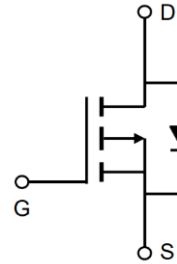


## 30V P-Channel Enhancement Mode MOSFET

### Description

The AP4435A uses advanced trench technology to provide excellent  $R_{DS(ON)}$ , low gate charge and operation with gate voltages as low as 4.5V. This device is suitable for use as a Battery protection or in other Switching application.



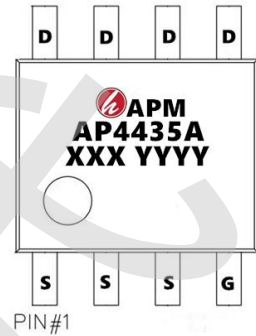
### General Features

$V_{DS} = -30V$   $I_D = -10.5A$

$R_{DS(ON)} < 16m\Omega$  @  $V_{GS} = -10V$

### Application

- Lithium battery protection
- Wireless impact
- Mobile phone fast charging



### Package Marking and Ordering Information

Product ID	Pack	Marking	Qty(PCS)
AP4435A	SOP-8	AP4435A XXX YYYY	3000

### Absolute Maximum Ratings (TC=25°C unless otherwise noted)

Symbol	Parameter	Rating	Units
$V_{DS}$	Drain-Source Voltage	-30	V
$V_{GS}$	Gate-Source Voltage	$\pm 20$	V
$I_D @ T_A = 25^\circ C$	Continuous Drain Current, $V_{GS} @ -10V^1$	-10.5	A
$I_D @ T_A = 70^\circ C$	Continuous Drain Current, $V_{GS} @ -10V^1$	-8.6	A
IDM	Pulsed Drain Current <sup>2</sup>	-50	A
EAS	Single Pulse Avalanche Energy <sup>3</sup>	72.2	mJ
IAS	Avalanche Current	-38	A
$P_D @ T_A = 25^\circ C$	Total Power Dissipation <sup>4</sup>	3.1	W
$P_D @ T_A = 70^\circ C$	Total Power Dissipation <sup>4</sup>	2	W
TSTG	Storage Temperature Range	-55 to 150	$^\circ C$
$T_J$	Operating Junction Temperature Range	-55 to 150	$^\circ C$
$R_{\theta JA}$	Thermal Resistance Junction-Ambient <sup>1</sup>	75	$^\circ C/W$
$R_{\theta JA}$	Thermal Resistance Junction-Ambient <sup>1</sup> ( $t \leq 10s$ )	40	$^\circ C/W$
$R_{\theta JC}$	Thermal Resistance Junction-Case <sup>1</sup>	24	$^\circ C/W$

## 30V P-Channel Enhancement Mode MOSFET

### Electrical Characteristics ( $T_J=25^\circ\text{C}$ , unless otherwise noted)

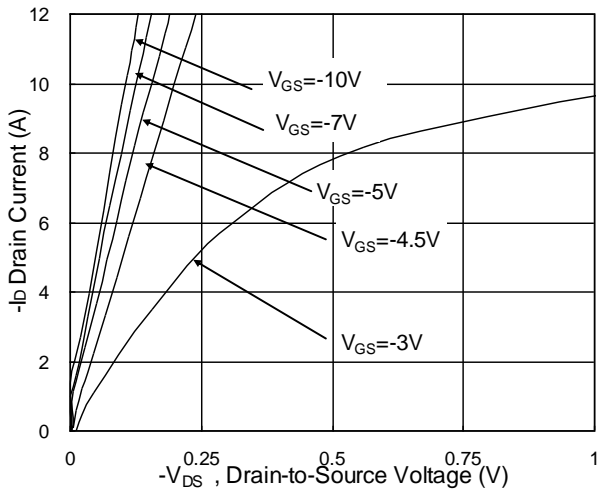
Symbol	Parameter	Conditions	Min.	Typ.	Max.	Unit
BVDSS	Drain-Source Breakdown Voltage	$V_{GS}=0V, I_D=-250\mu A$	-30	-32	---	V
$\Delta BVDSS/\Delta T_J$	$BV_{DSS}$ Temperature Coefficient	Reference to $25^\circ\text{C}$ , $I_D=-1mA$	---	-0.022	---	$V/^\circ\text{C}$
RDS(ON)	Static Drain-Source On-Resistance <sup>2</sup>	$V_{GS}=-10V, I_D=-10A$	---	12	16	m $\Omega$
		$V_{GS}=-4.5V, I_D=-5A$	---	18	24	
VGS(th)	Gate Threshold Voltage	$V_{GS}=V_{DS}, I_D=-250\mu A$	-1.0	-1.6	-2.5	V
$\Delta V_{GS(th)}$	$V_{GS(th)}$ Temperature Coefficient		---	4.6	---	$mV/^\circ\text{C}$
IDSS	Drain-Source Leakage Current	$V_{DS}=-24V, V_{GS}=0V, T_J=25^\circ\text{C}$	---	---	-1	uA
		$V_{DS}=-24V, V_{GS}=0V, T_J=55^\circ\text{C}$	---	---	-5	
IGSS	Gate-Source Leakage Current	$V_{GS}=\pm 20V, V_{DS}=0V$	---	---	$\pm 100$	nA
gfs	Forward Transconductance	$V_{DS}=-5V, I_D=-5A$	---	17	---	S
$R_g$	Gate Resistance	$V_{DS}=0V, V_{GS}=0V, f=1MHz$	---	13	---	$\Omega$
$Q_g$	Total Gate Charge (-4.5V)	$V_{DS}=-15V, V_{GS}=-4.5V, I_D=-6A$	---	30	---	nC
$Q_{gs}$	Gate-Source Charge		---	6	---	
$Q_{gd}$	Gate-Drain Charge		---	9	---	
$T_d(on)$	Turn-On Delay Time	$V_{DD}=-15V, V_{GS}=-10V, R_G=3.3\Omega, I_D=-6A$	---	10	---	ns
$T_r$	Rise Time		---	26	---	
$T_d(off)$	Turn-Off Delay Time		---	35	---	
$T_f$	Fall Time		---	8	---	
$C_{iss}$	Input Capacitance	$V_{DS}=-15V, V_{GS}=0V, f=1MHz$	---	1800	---	pF
$C_{oss}$	Output Capacitance		---	305	---	
$C_{rss}$	Reverse Transfer Capacitance		---	216	---	
IS	Continuous Source Current <sup>1,5</sup>	$V_G=V_D=0V, \text{Force Current}$	---	---	-10	A
ISM	Pulsed Source Current <sup>2,5</sup>		---	---	-50	A
VSD	Diode Forward Voltage <sup>2</sup>	$V_{GS}=0V, I_S=-1A, T_J=25^\circ\text{C}$	---	---	-1.2	V
trr	Reverse Recovery Time	$I_F=-6A, di/dt=100A/\mu s, T_J=25^\circ\text{C}$	---	16.3	---	nS
$Q_{rr}$	Reverse Recovery Charge		---	5.9	---	nC

#### Note :

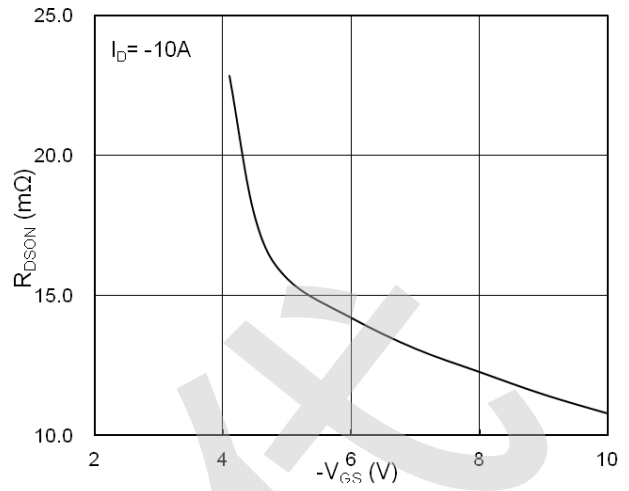
- 1、The data tested by surface mounted on a 1 inch 2 FR-4 board with 2OZ copper.
- 2、The data tested by pulsed , pulse width  $\leq 300\mu s$  , duty cycle  $\leq 2\%$
- 3、The EAS data shows Max. rating . The test condition is  $V_{DD}=-25V, V_{GS}=-10V, L=0.1mH, I_{AS}=-38A$
- 4、The power dissipation is limited by  $150^\circ\text{C}$  junction temperature
- 5、The data is theoretically the same as ID and IDM , in real applications , should be limited by total power dissipation.

**30V P-Channel Enhancement Mode MOSFET**

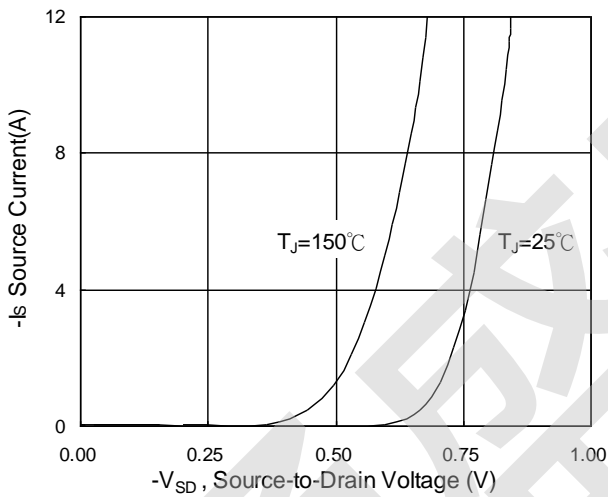
**Typical Characteristics**



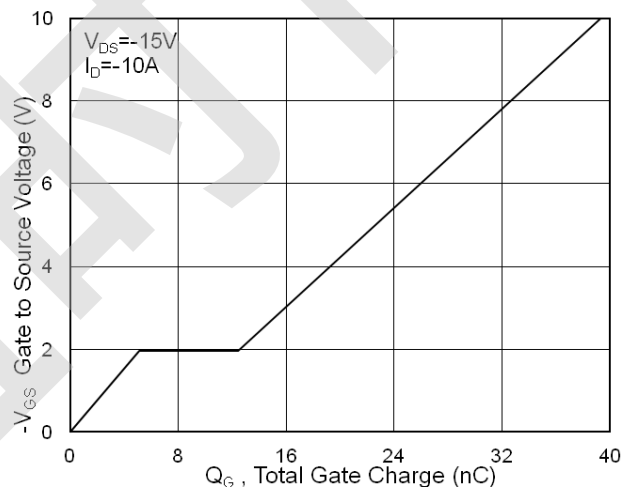
**Fig.1 Typical Output Characteristics**



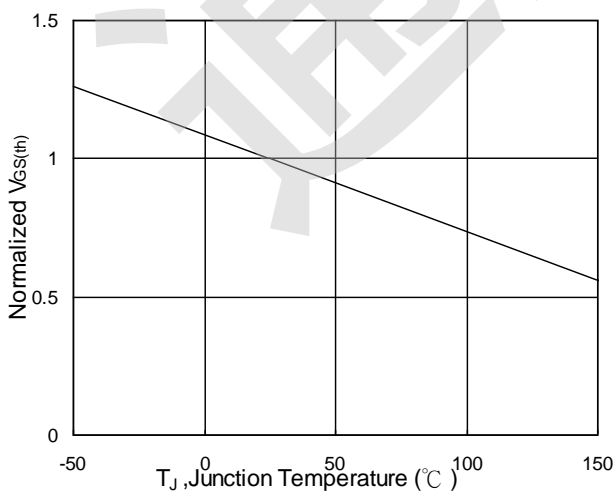
**Fig.2 On-Resistance vs. G-S Voltage**



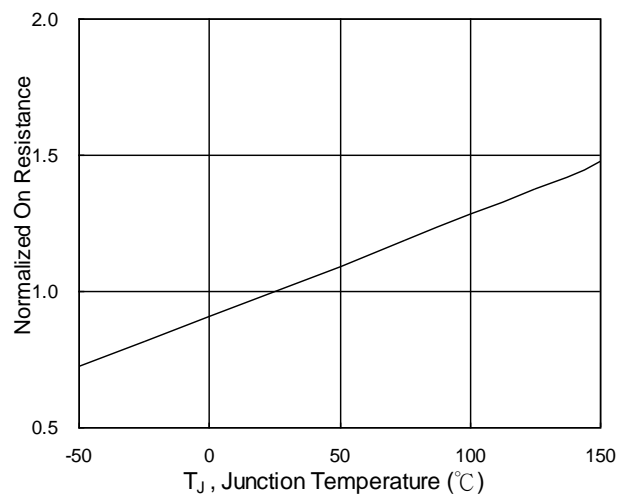
**Fig.3 Forward Characteristics of Reverse**



**Fig.4 Gate-charge Characteristics**

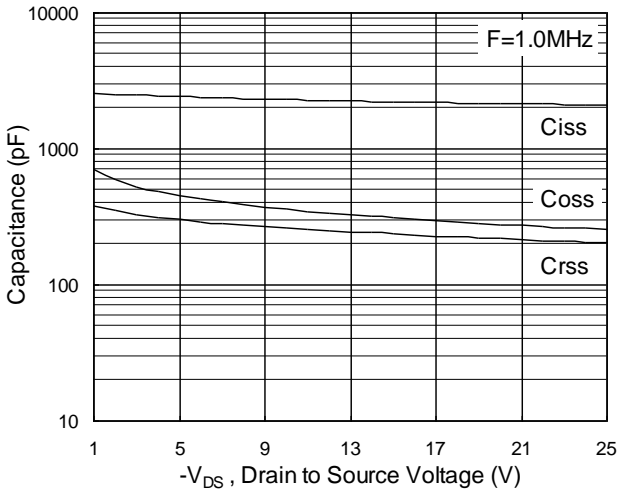


**Fig.5 Normalized  $V_{GS(th)}$  vs.  $T_J$**

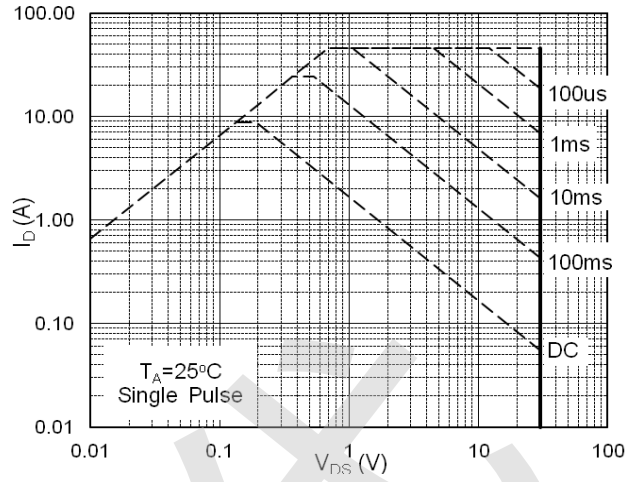


**Fig.6 Normalized  $R_{DS(on)}$  vs.  $T_J$**

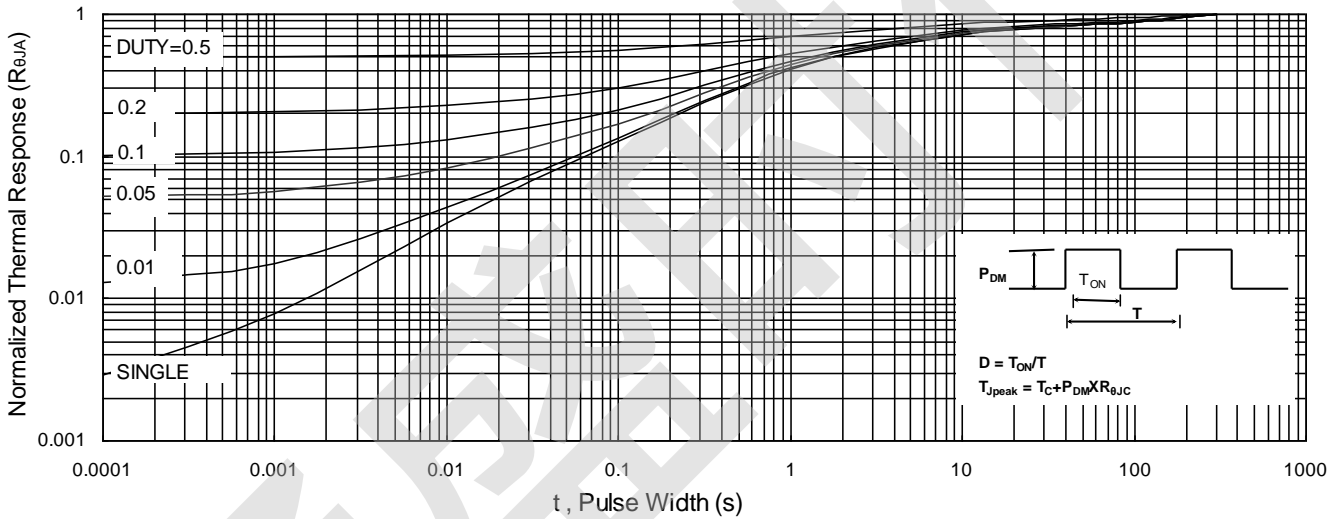
**30V P-Channel Enhancement Mode MOSFET**



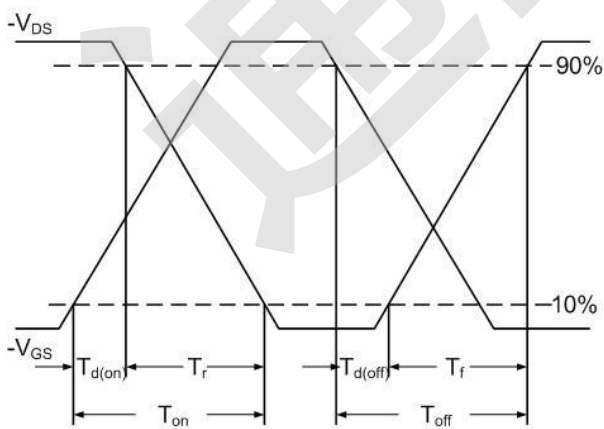
**Fig.7 Capacitance**



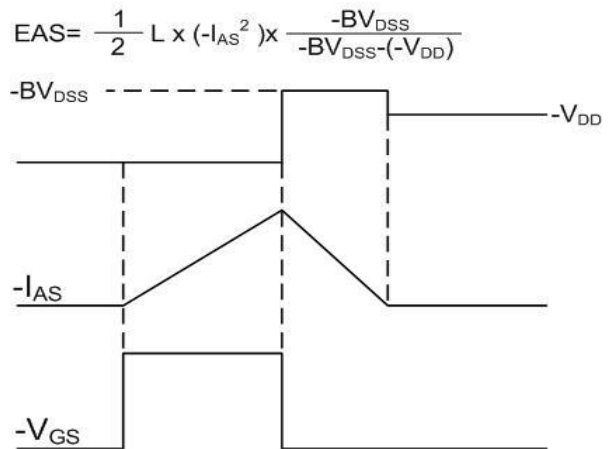
**Fig.8 Safe Operating Area**



**Fig.9 Normalized Maximum Transient Thermal Impedance**



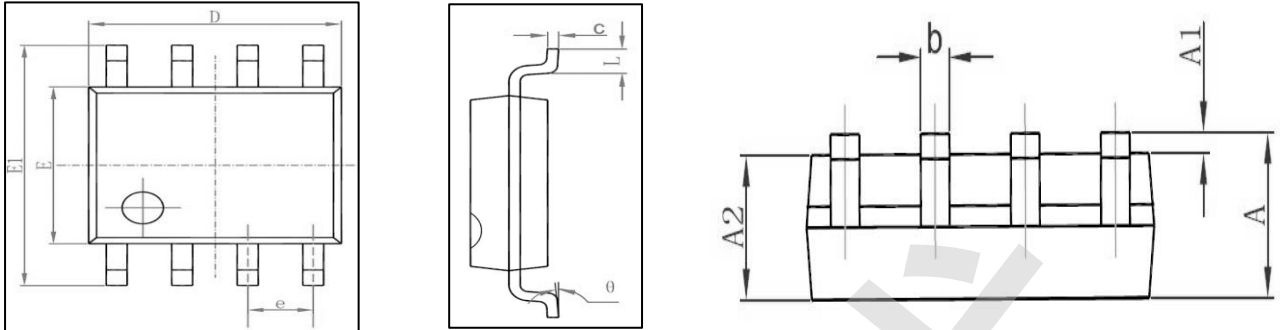
**Fig.10 Switching Time Waveform**



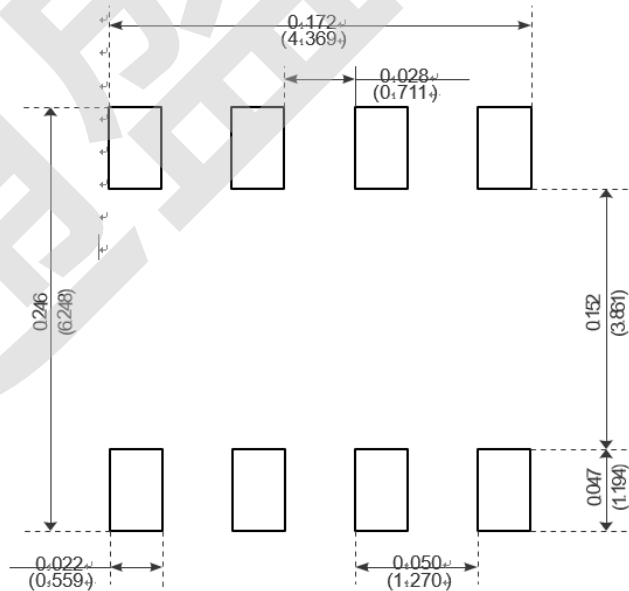
**Fig.11 Unclamped Inductive Waveform**

## 30V P-Channel Enhancement Mode MOSFET

### Package Mechanical Data-SOP-8



Symbol	Dimensions In Millimeters		Dimensions In Inches	
	Min	Max	Min	Max
A	1.350	1.750	0.053	0.069
A1	0.100	0.250	0.004	0.010
A2	1.350	1.550	0.053	0.061
b	0.330	0.510	0.013	0.020
c	0.170	0.250	0.006	0.010
D	4.700	5.100	0.185	0.200
E	3.800	4.000	0.150	0.157
E1	5.800	6.200	0.228	0.244
e	1.270 (BSC)		0.050 (BSC)	
L	0.400	1.270	0.016	0.050
θ	0°	8°	0°	8°



Recommended Minimum Pads

## 30V P-Channel Enhancement Mode MOSFET Attention

- 1, Any and all APM Microelectronics products described or contained herein do not have specifications that can handle applications that require extremely high levels of reliability, such as life support systems, aircraft's control systems, or other applications whose failure can be reasonably expected to result in serious physical and/or material damage. Consult with your APM Microelectronics representative nearest you before using any APM Microelectronics products described or contained herein in such applications.
- 2, APM Microelectronics assumes no responsibility for equipment failures that result from using products at values that exceed, even momentarily, rated values (such as maximum ratings, operating condition ranges, or other parameters) listed in products specifications of any and all APM Microelectronics products described or contained herein.
- 3, Specifications of any and all APM Microelectronics products described or contained here instipulate the performance, characteristics, and functions of the described products in the independent state, and are not guarantees of the performance, characteristics, and functions of the described products as mounted in the customer's products or equipment. To verify symptoms and states that cannot be evaluated in an independent device, the customer should always evaluate and test devices mounted in the customer's products or equipment.
- 4, APM Microelectronics Semiconductor CO., LTD. strives to supply high quality high reliability products. However, any and all semiconductor products fail with some probability. It is possible that these probabilistic failures could give rise to accidents or events that could endanger human lives that could give rise to smoke or fire, or that could cause damage to other property. When designing equipment, adopt safety measures so that these kinds of accidents or events cannot occur. Such measures include but are not limited to protective circuits and error prevention circuits for safe design, redundant design, and structural design.
- 5, In the event that any or all APM Microelectronics products (including technical data, services) described or contained herein are controlled under any of applicable local export control laws and regulations, such products must not be exported without obtaining the export license from the authorities concerned in accordance with the above law.
- 6, No part of this publication may be reproduced or transmitted in any form or by any means, electronic or mechanical, including photocopying and recording, or any information storage or retrieval system, or otherwise, without the prior written permission of APM Microelectronics Semiconductor CO., LTD.
- 7, Information (including circuit diagrams and circuit parameters) herein is for example only; it is not guaranteed for volume production. APM Microelectronics believes information herein is accurate and reliable, but no guarantees are made or implied regarding its use or any infringements of intellectual property rights or other rights of third parties.
- 8, Any and all information described or contained herein are subject to change without notice due to product/technology improvement, etc. When designing equipment, refer to the "Delivery Specification" for the APM Microelectronics product that you intend to use.



## 30V P-Channel Enhancement Mode MOSFET

Edition	Date	Change
Rve1.0	2018/1/31	Initial release
Rve1.2	2019/5/25	Reduce CiSS and QG
Rve1.3	2020/6/20	Reduce RDS

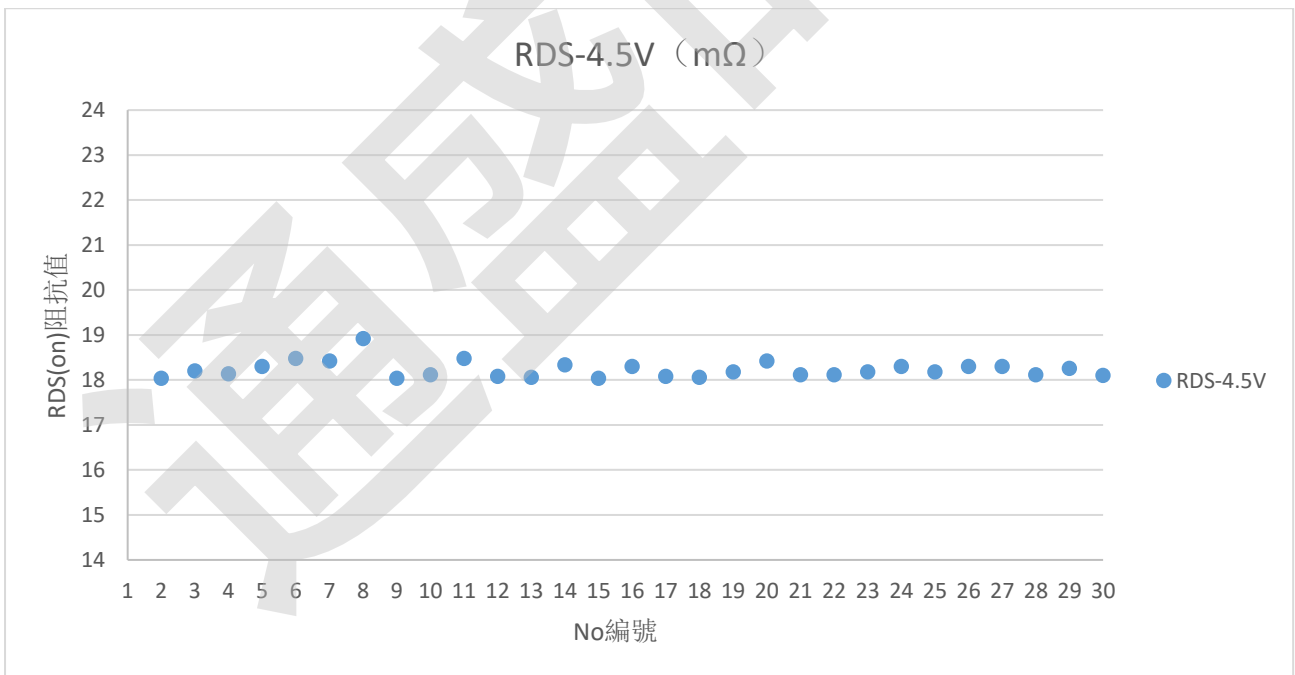
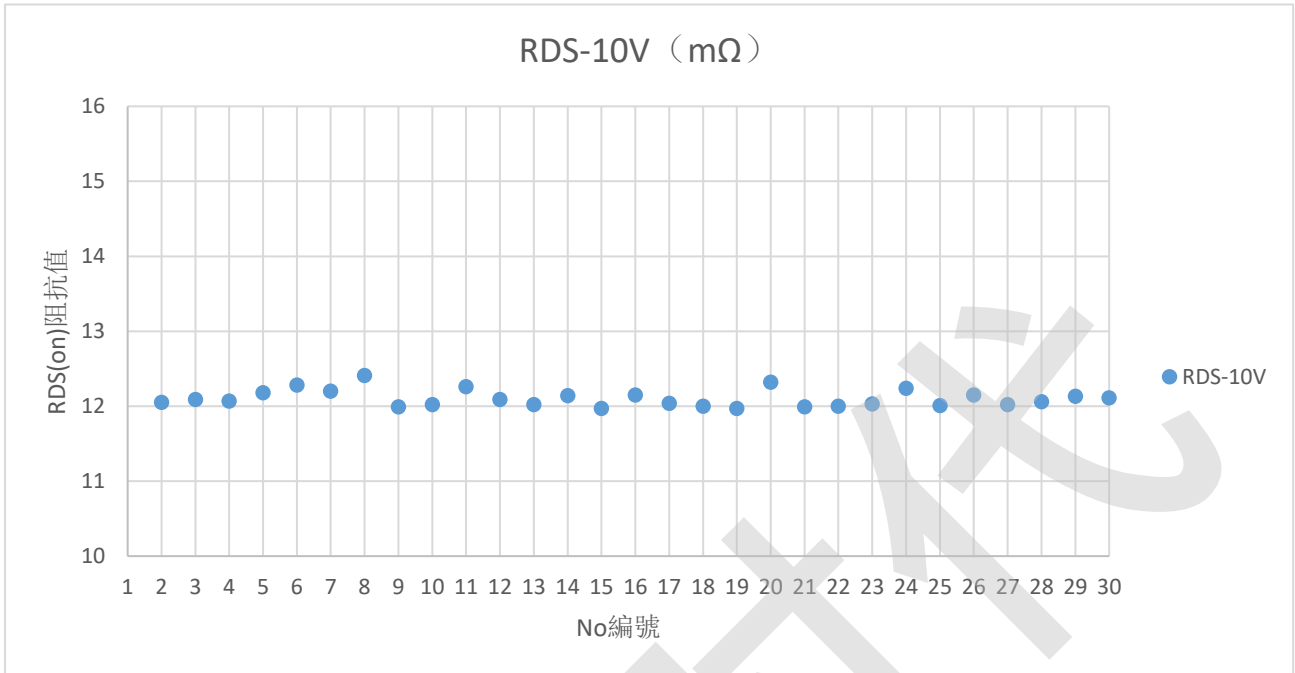
Copyright Attribution“APM-Microelectronice”

通盛时代



## 30V P-Channel Enhancement Mode MOSFET

### Test Report For 30PCS (30pcs 典型測試報告)







## 30V P-Channel Enhancement Mode MOSFET

